

WILL ACCEPT 26-20 AWG WIRE

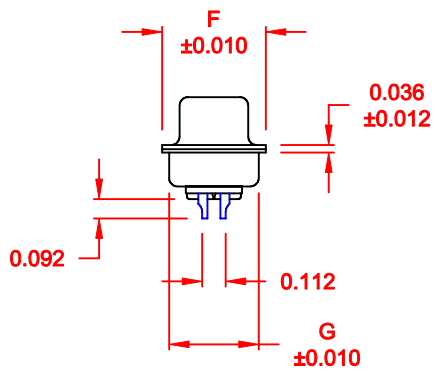
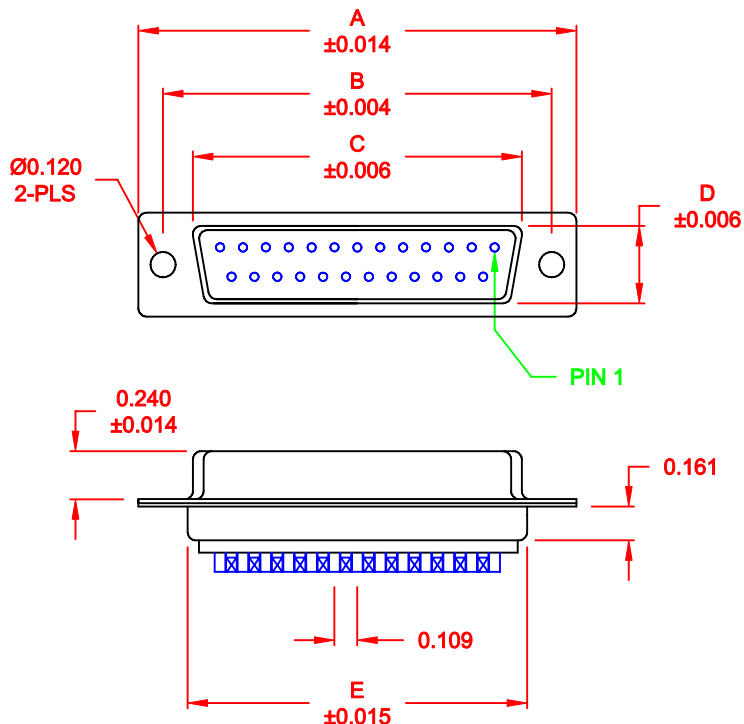

No. OF PINS	DIMENSIONS						
	A	B	C	D	E	F	G
9	1.213	0.984	0.642	0.315	0.760	0.480	0.429
	30.80	24.99	16.30	8.00	19.30	12.20	10.90
15	1.541	1.312	0.969	0.315	1.083	0.480	0.429
	39.15	33.32	24.60	8.00	27.51	12.20	10.90
25	2.088	1.852	1.512	0.315	1.630	0.480	0.429
	53.04	47.04	38.40	8.00	41.40	12.20	10.90
37	2.729	2.500	2.157	0.315	2.276	0.480	0.429
	69.32	63.50	54.80	8.00	57.81	12.20	10.90
50	2.635	2.406	2.059	0.425	2.182	0.598	0.535
	66.93	61.11	52.30	10.80	55.42	15.20	13.60

172-YYY-202RYY1

- SERIES _____
- POSITIONS _____
- 009 _____
- 015 _____
- 025 _____
- 037 _____
- 050 _____
- GENDER _____
- 2 = FEMALE
- TERMINATION _____
- 0 = SOLDER CUP
- SHELL PLATING _____
- 2 = TIN
- RoHS COMPLIANT _____
- HARDWARE OPTIONS _____
- 00 = NO HARDWARE
- 01 = .065" CLINCH NUT (BOARD SIDE)
- 02 = .250" CLINCH NUT (BOARD SIDE)
- 03 = .250" CLINCH NUT (MOUNTING SIDE)
- 05 = .237" 4-40 BOARD LOCK
- 91 = .237" 4-40 SPACER/ BOARD LOCK
- PLATING OPTIONS _____
- 1 = GOLD FLASH
- 2 = 30MICRO-INCH GOLD

MATERIAL:

- SHELL: STEEL, TIN PLATED
- INSULATOR: UL 94V-O RATED, PBTP-BEIGE, 30% FIBER-GLASS
- PROCESS TEMP.: 260° C
- CONTACT: BRASS

ELECTRICAL:

- CURRENT RATING: 5 AMPS
- CONTACT RESISTANCE: 15 mOhms Max.
- INSULATION RESISTANCE: 1,000 MOhms min.
- VOLTAGE: 500VAC FOR 1 MINUTE
- TEMPERATURE: -50° C TO 100° C

DO NOT SCALE FROM DRAWING

RoHS COMPLIANT

	THESE DRAWINGS AND SPECIFICATIONS ARE THE PROPERTY OF NorComp AND SHALL NOT BE REPRODUCED, COPIED OR USED AS THE BASIS FOR THE MANUFACTURE OF SALE OF APPARATUS WITHOUT WRITTEN PERMISSION.		DRAWN: PAM JENKINS CHECKED:	DATE: 08-24-98 DATE:
	<h1>NorComp</h1>		SCALE: 1:1 DWG NO. 172-YYY-202RYY1	SHEET 1 OF 2 REV 9

ALL CLINCH-NUTS ARE 4-40 INTERNAL THREADS

01X 0.065" (BOARD SIDE) - CN1

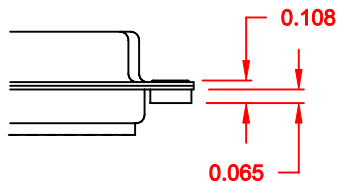

05X 0.237" (BOARD SIDE) - CN10

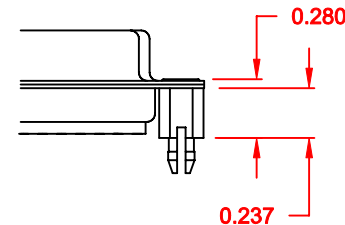

02X 0.250" (BOARD SIDE) - CN2

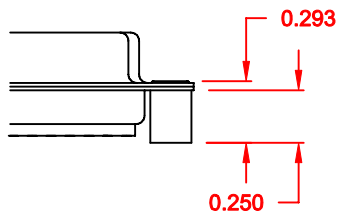

91X 0.237" (BOARD SIDE) - 0.197" MATING SIDE - CN10/SFSO4404

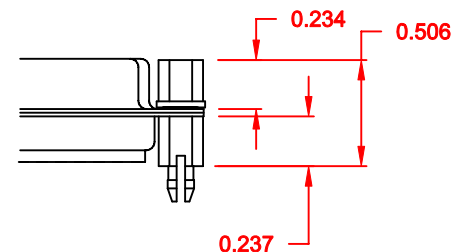

03X..... 0.250" (MATING SIDE) - CN8

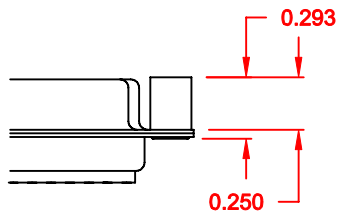

NOTE: 4-40 FEMALE SCREW LOCK IS REMOVABLE

DO NOT SCALE FROM DRAWING

RoHS COMPLIANT

	THESE DRAWINGS AND SPECIFICATIONS ARE THE PROPERTY OF NorComp AND SHALL NOT BE REPRODUCED, COPIED OR USED AS THE BASIS FOR THE MANUFACTURE OF SALE OF APPARATUS WITHOUT WRITTEN PERMISSION.		DRAWN: WAYNE ROBBINS	DATE: 11-28-05
			CHECKED:	DATE:
<h1>NorComp</h1>		SCALE:	SHEET 2 OF 2	REV 9
		DWG NO. 172-YYY-202RYY1		